

RECHENFRÜHSTÜCK - WOCHE 7

Name: _____

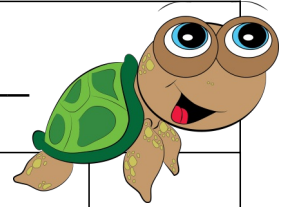

$62 + \underline{\quad} = 72$	$\underline{\quad} - 47 = 24$	$17 - \underline{\quad} = 1$
$\underline{\quad} : 4 = 3$	$\underline{\quad} + 16 = 87$	$49 + \underline{\quad} = 73$
$\underline{\quad} \cdot 3 = 27$	$64 : \underline{\quad} = 8$	$\underline{\quad} \cdot 2 = 20$
$\underline{\quad} - 39 = 29$	$10 \cdot \underline{\quad} = 30$	$14 + \underline{\quad} = 32$
$\underline{\quad} + 21 = 71$	$42 - \underline{\quad} = 20$	$28 - \underline{\quad} = 6$
$1 \cdot \underline{\quad} = 5$	$12 : \underline{\quad} = 4$	$60 : \underline{\quad} = 10$
$\underline{\quad} : 6 = 9$	$7 \cdot \underline{\quad} = 28$	$\underline{\quad} + 12 = 36$

MI

$56 : \underline{\quad} = 7$	$54 + \underline{\quad} = 75$	$\underline{\quad} \cdot 2 = 20$
$\underline{\quad} \cdot 7 = 49$	$8 \cdot 4 = \underline{\quad}$	$71 + \underline{\quad} = 90$
$\underline{\quad} - 64 = 22$	$79 + \underline{\quad} = 93$	$44 + \underline{\quad} = 63$
$27 + 50 = \underline{\quad}$	$\underline{\quad} : 6 = 7$	$\underline{\quad} \cdot 2 = 18$
$85 - \underline{\quad} = 49$	$\underline{\quad} - 60 = 30$	$24 : 8 = \underline{\quad}$
$7 \cdot 2 = \underline{\quad}$	$12 - \underline{\quad} = 1$	$47 - 21 = \underline{\quad}$
$\underline{\quad} : 4 = 7$	$\underline{\quad} : 6 = 1$	$1 \cdot \underline{\quad} = 2$

DO

$\underline{\quad} + 27 = 58$	$\underline{\quad} : 4 = 3$	$\underline{\quad} + 10 = 99$
$52 - 6 = \underline{\quad}$	$9 \cdot 4 = \underline{\quad}$	$\underline{\quad} \cdot 5 = 45$
$5 \cdot 2 = \underline{\quad}$	$15 - \underline{\quad} = 7$	$\underline{\quad} : 4 = 7$
$\underline{\quad} : 5 = 8$	$13 + \underline{\quad} = 46$	$8 \cdot \underline{\quad} = 16$
$50 + 42 = \underline{\quad}$	$63 : 9 = \underline{\quad}$	$51 + 29 = \underline{\quad}$
$36 - 2 = \underline{\quad}$	$55 - 4 = \underline{\quad}$	$21 - 3 = \underline{\quad}$
$\underline{\quad} \cdot 4 = 16$	$\underline{\quad} : 2 = 4$	$24 : 6 = \underline{\quad}$

FR

RECHENFRÜHSTÜCK - WOCHE 8

Name: _____

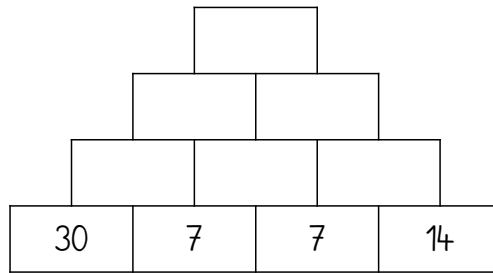
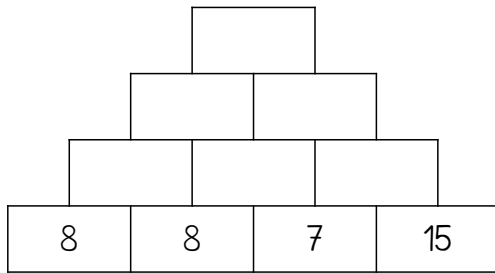
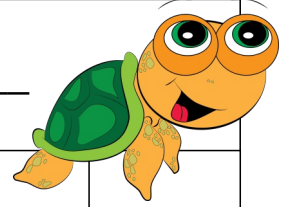

MO

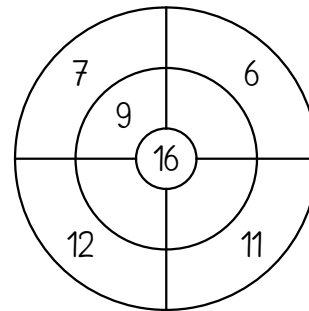
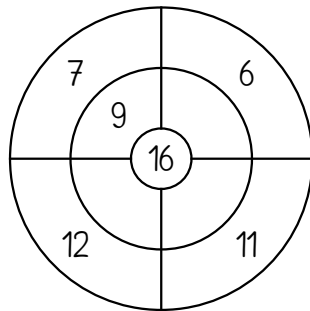
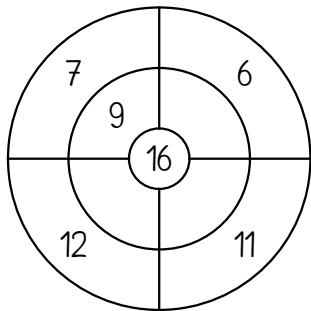

DI

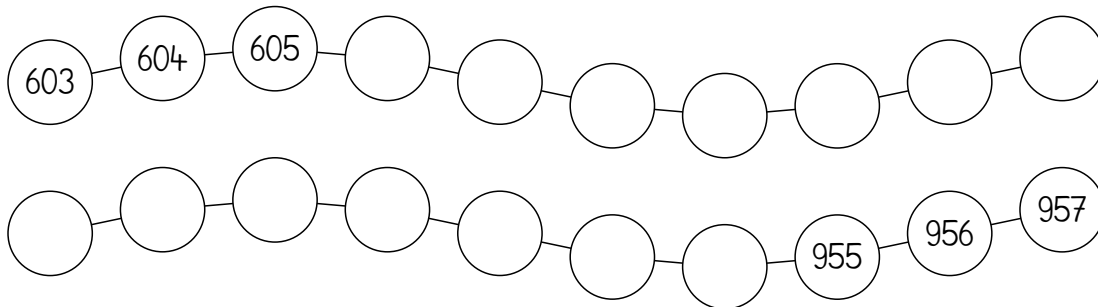

MI

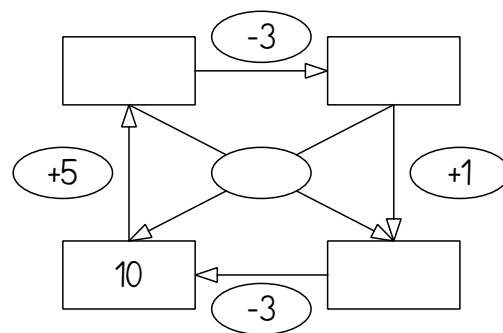
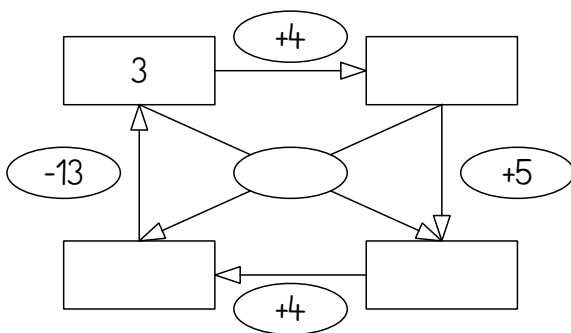

DO

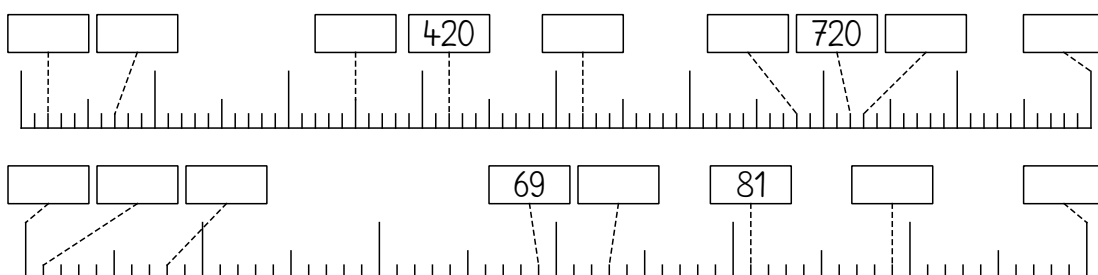

FR

RECHENFRÜHSTÜCK - WOCHE 7

Name: _____

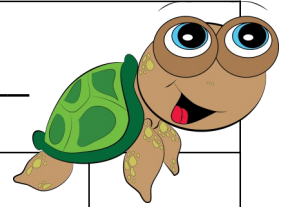

$62 + \underline{10} = 72$

$\underline{71} - 47 = 24$

$17 - \underline{16} = 1$

$\underline{12} : 4 = 3$

$\underline{71} + 16 = 87$

$49 + \underline{24} = 73$

$\underline{9} \cdot 3 = 27$

$64 : \underline{8} = 8$

$\underline{10} \cdot 2 = 20$

$\underline{68} - 39 = 29$

$10 \cdot \underline{3} = 30$

$14 + \underline{18} = 32$

$\underline{50} + 21 = 71$

$42 - \underline{22} = 20$

$28 - \underline{22} = 6$

$1 \cdot \underline{5} = 5$

$12 : \underline{3} = 4$

$60 : \underline{6} = 10$

$\underline{54} : 6 = 9$

$7 \cdot \underline{4} = 28$

$\underline{24} + 12 = 36$

MI

$56 : \underline{8} = 7$

$54 + \underline{21} = 75$

$\underline{10} \cdot 2 = 20$

$\underline{7} \cdot 7 = 49$

$8 \cdot 4 = \underline{32}$

$71 + \underline{19} = 90$

$\underline{86} - 64 = 22$

$79 + \underline{14} = 93$

$44 + \underline{19} = 63$

$27 + 50 = \underline{77}$

$\underline{42} : 6 = 7$

$\underline{9} \cdot 2 = 18$

$85 - \underline{36} = 49$

$\underline{90} - 60 = 30$

$24 : 8 = \underline{3}$

$7 \cdot 2 = \underline{14}$

$12 - \underline{11} = 1$

$47 - 21 = \underline{26}$

$\underline{28} : 4 = 7$

$\underline{6} : 6 = 1$

$1 \cdot \underline{2} = 2$

DO

$\underline{31} + 27 = 58$

$\underline{12} : 4 = 3$

$\underline{89} + 10 = 99$

$52 - 6 = \underline{46}$

$9 \cdot 4 = \underline{36}$

$\underline{9} \cdot 5 = 45$

$5 \cdot 2 = \underline{10}$

$15 - \underline{8} = 7$

$\underline{28} : 4 = 7$

$\underline{40} : 5 = 8$

$13 + \underline{33} = 46$

$8 \cdot \underline{2} = 16$

$50 + 42 = \underline{92}$

$63 : 9 = \underline{7}$

$51 + 29 = \underline{80}$

$36 - 2 = \underline{34}$

$55 - 4 = \underline{51}$

$21 - 3 = \underline{18}$

$\underline{4} \cdot 4 = 16$

$\underline{8} : 2 = 4$

$24 : 6 = \underline{4}$

FR

RECHENFRÜHSTÜCK - WOCHE 8

Name: _____

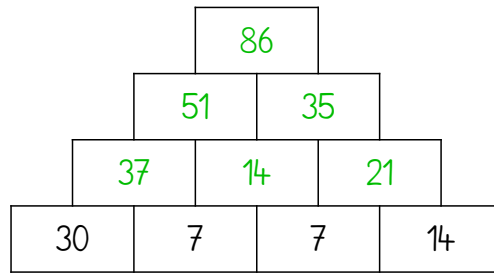
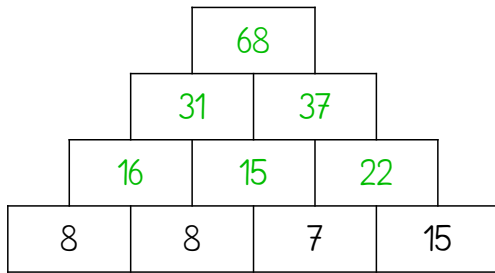
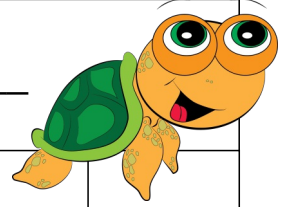

MO

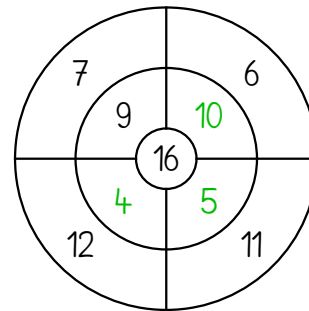
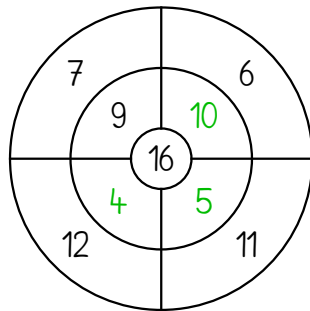
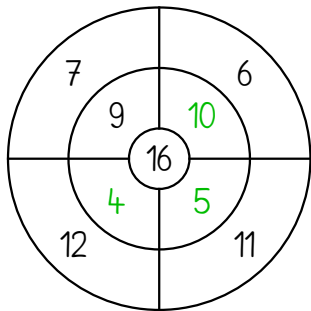

DI

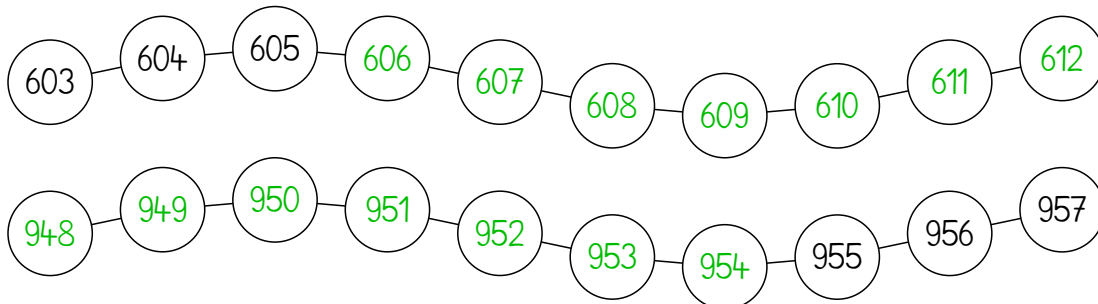

MI

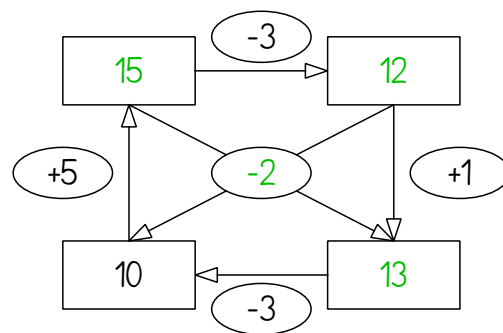
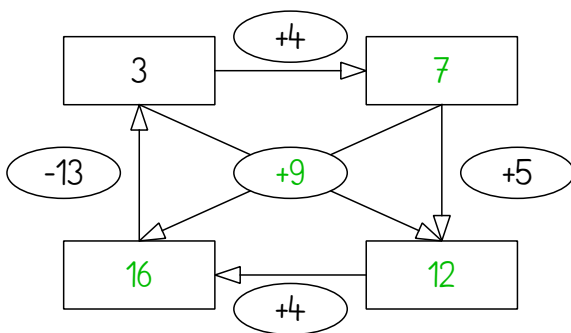

DO

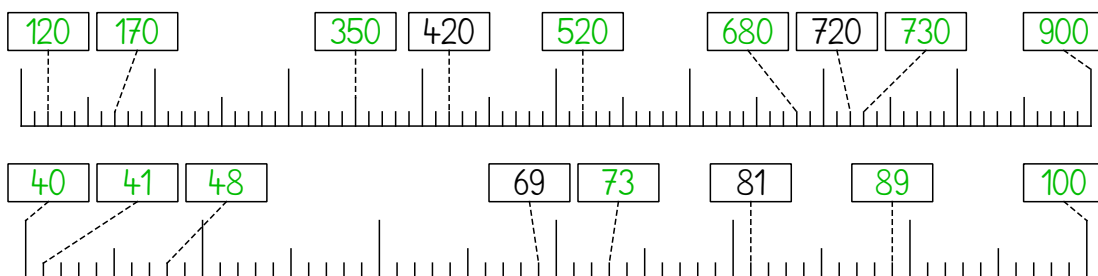

FR